

# Home Entertainment Mounting Systems



2009

## Table of contents

■ The ultimate viewing experience .....	3
■ About VESA Standard .....	4
■ The story behind the Touch & Tilt technology ..	5
■ 12"-26" LCD Wall Mounts .....	6-7
■ 12"-22" LCD Desk Mounts .....	8-11
■ 12"-42" LCD Wall Mounts .....	12-17
■ 40"-60" LCD/Plasma Wall Mounts .....	18-21
■ Fits up to 70" LCD/Plasma Wall Mounts .....	22-25
■ Wall Mounted Audio Video Shelves .....	26-27
■ Projector Ceiling Mounts .....	28
■ Speaker Wall Mounts .....	29
■ TV & Audio Video Wall Mounts .....	30-33
■ Barkan Vision & Strategy .....	34-35
■ Selection Guide .....	38

# Quality



For the ultimate viewing experience,  
position the screen towards you.

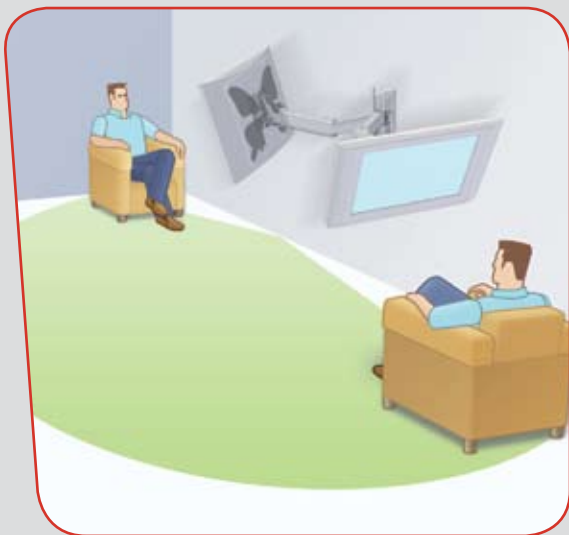

### **Barkan Swivel Mounts for LCD/Plasma Screens**

Elegantly designed LCD / Plasma mounts, which adjust to any angle for ultimate viewing from anywhere in the room.

#### **All swivel mounts include:**

- ▶ A tools-free, "touch and tilt" patent pending mechanism, for screen adjustment, enabled by automotive friction brake-pads.
- ▶ Self assembly in three easy steps .
- ▶ A fall and theft proof locking system.
- ▶ Cable management for a clean, wire-free look.
- ▶ Built in screen leveling, using the VESA butterfly connection.

- ▶ **Designed to fit:** SHARP, SONY, PHILIPS, SAMSUNG, TOSHIBA, PANASONIC, NEC, LG, PIONEER, RCA/THOMSON, JVC, DELL, FUJITSU, LOEWE, AKAI, HITACHI, OLEVIA, HAIER, TELEFUNKEN, WESTINGHOUSE, SANYO & Other popular brands.

## ***Innovative & exclusive Butterfly Connection***

Registered Design  
(pending) 955760

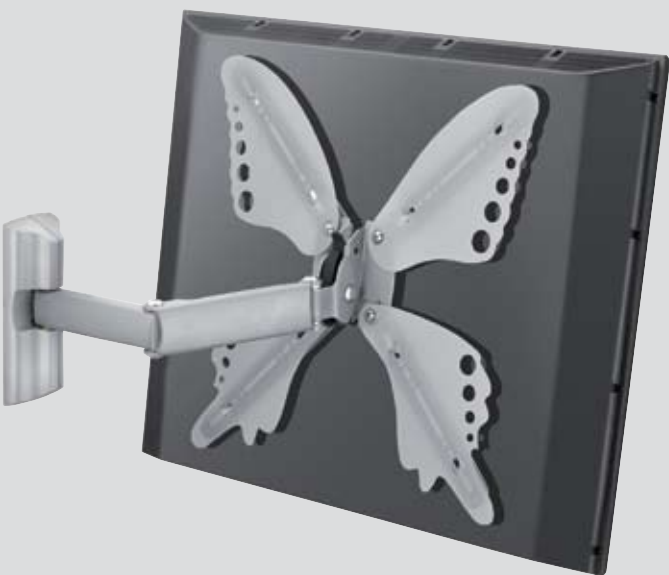

**About VESA Standard:** VESA is an international standard for flat screen (LCD and Plasma) manufacturers and for manufacturers of screen mounts, and defines the manner of attachment using screws. Barkan LCD/ Plasma mounts comply with the VESA standard, and are suitable for screens with threading (holes for screws) on the back of screens that comply with the standard. 50/75/100/200 indicated next to VESA compliance means compatibility with screens that have 4 threading holes (holes for screws) on the back of the screen, with the horizontal and vertical distance between each two threading holes according to 50x50mm / 75x75mm / 100x100mm / 100x200mm / 200x200mm.

# LCD/Plasma Wall Mounts

The story behind the "Touch & Tilt" technology.

Luxury designed, convenient to use and unique features that improve the viewing experience.

We had been looking for a tools-free solution that would allow for the flexible movement and ultimate viewing position. We tested numerous types of friction pads from plastic to steel. None met our specific demands as the screen failed to remain in the same position. One day, one of our engineers asked a very simple question "Which material used in our daily life has a very high friction coefficient?" After a few moments of silence he answered "friction pads in the brakes of the car you are driving". We re-designed the brake friction pads for our touch & tilt mechanism. Now you can tilt the screen at any angle and count on the "brake pads" to hold the screen in the perfect viewing position. Barkan has a worldwide patent on this technology.

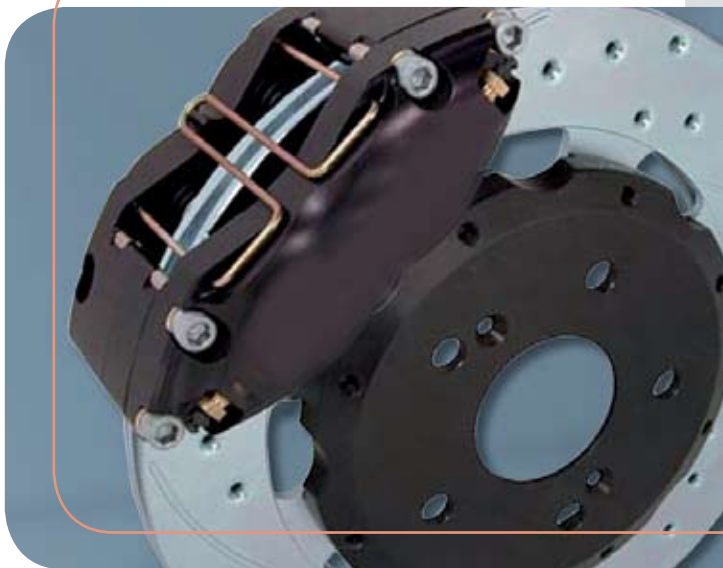

# 12"-26" LCD Wall Mounts

## 30-66cm

Excellent solution designed for  
Monitor / Small LCD screens

**Weight up to:** for models 20-22: 66lbs/30kg,  
for models 23-24: 44lbs/20kg

- Entry level for Small Screens.
- For back screen mounting holes: 75x75, 100x100 mm LCD's (VESA standard).
- For back screen mounting holes up to 200x200 mm LCD's use mount with **38** adaptor. See page 10.
- Also compatible to: larger screen sizes where their specifications comply to the mount, computer screens.

### 20 Fixed

Color



- Distance from wall: 0.9"/2.4 cm

### 21 Tilt

Color



**NEW**  
Release 12/08

- Distance from wall: 2.75"/7 cm

#### SELF ASSEMBLY

as easy as **1-2-3**

- 1- Install the mount on the wall.
- 2- Partially screw the four locking screws into the back screen mounting holes.
- 3- Snap the screen onto the wall bracket and tighten the locking screws.

#### TOUCH & TILT

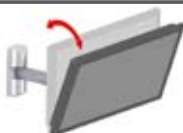

Patent Pend PCT 2005/000373

Tools free tilt adjustment, enabled by automotive friction brake-pads.

22

**2 Movement**

Swivel &amp; Tilt

**NEW**  
 Special order only

- Distance from wall: 3.75"/9.5 cm

23

**3 Movement**

Rotate, Swivel &amp; Tilt

**NEW**  
 Release 12/08

- Minimum distance from wall: 3.25"/8.5 cm
- Maximum distance from wall: 9.5"/24 cm

24

**4 Movement**

Fold, Rotate, Swivel &amp; Tilt

**NEW**  
 Release 12/08

- Minimum distance from wall: 4"/10 cm
- Maximum distance from wall: 15.75"/40 cm

**FALL & THEFT PROOF**

Secure locking system,  
preventing theft and accidents.

**SCREEN LEVELING**

A built-in mechanism to adjust  
the screen.

# 12"-22" LCD Desk Mounts

30-56cm

Clean and smooth design Desk Mounts for flat panel monitors, which frees up table space with tool free fold, swivel and tilt screen adjustment.

**Weight up to:** 22lbs/10kg

- Attaches to the table edge by clamp or special bracket assembly to a hole in the table.
- For back screen mounting holes: 75x75, 100x100mm LCD's (VESA standard).
- For back screen mounting holes up to 200x200 mm LCD's use mount with 38 adaptor.
- Also compatible to: larger screen sizes where their specifications comply to the mount, computer screens.

## 26 LCD Desk Mount

Color



### CABLE MANAGEMENT



Hides cables inside the mount for a clean, wire-free look.

### FRICITION ADJUSTMENT



One handed tighten or release tilt resistance mechanism.



26-2

## LCD Desk Mount

For 2 Screens

Color  
● ●

**NEW**  
Release 03/09



26-N

## Laptop Desk Mount

Color  
● ●

**NEW**  
Release 03/09



# 12"-22" LCD Desk Mounts

30-56cm

26-1N

**Combo**  
LCD & Laptop Desk Mount

Color

**NEW**  
Release 03/09



38

**LCD Mount Adaptor Extension**

Color

**NEW**



- For back screen mounting holes up to: 200x200 mm



# 12"-42" LCD Wall Mounts

## 30-107cm

Luxury mounts using our unique and innovative Butterfly Connection

Weight up to: 66lbs/30kg

- For back screen mounting holes up to 400 x 400 mm LCD's (VESA and non VESA). Includes: 75x75, 100x100, 100x200, 200x200 mm
- For back screen mounting holes up to 600 x 400 mm LCD's use mount with **38** adaptor
- Also compatible to: larger screen sizes where their specifications comply to the mount.

Color



**30P**

### PRO Fixed

Weight up to: 132lbs/60kg



**NEW**

• Distance from wall: 1.8"/4.6 cm

#### HEIGHT ADJUSTMENT

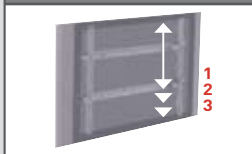

Choice of 3 height positions for enhanced viewing quality

#### LEFT & RIGHT ADJUSTMENT

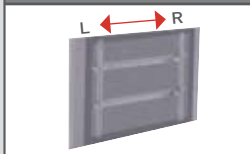

Easy screen positioning during installation, for enhanced viewing quality

#### SELF ASSEMBLY

as easy as **1-2-3**

- 1- Install the bracket on the wall.
- 2- Attach the mounting fixture to the screen.
- 3- Snap the screen onto the wall bracket.

#### TOUCH & TILT



Patent Pend PCT 2005/000373

Tools free tilt adjustment, enabled by automotive friction brake-pads.

# 12"-42" LCD Wall Mounts

30-107cm

## 30 Fixed

Color



•Distance from wall: 0.9"/2.4 cm

## 31 Tilt

Color

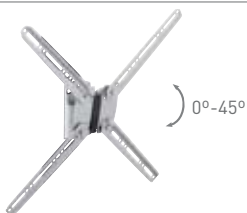

•Distance from wall: 2.75"/7 cm

## 32 2 Movement

Swivel & Tilt

Color



•Distance from wall: 3.75"/9.5 cm

### FALL & THEFT PROOF



Secure locking system, preventing theft and accidents.

### SCREEN LEVELING

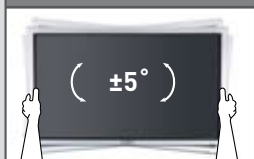

A built-in mechanism to adjust the screen.

## The "Butterfly" design story, patented for mounting systems

We looked for additional ways to improve the viewing pleasures of end users with Barkan products. We consulted with numerous designers and all suggested subtle changes without jeopardizing the integrity of the product. We weren't satisfied with the proposals, and continued to search for an original idea. One day, our in-house designer looked at our connecting mechanism and suggested "why not design a mechanism similar to an animal all are familiar with". We tried a number of animals and came up with a butterfly shape. Animals in the wild, through generations of evolution, have developed a body structure enabling them optimal and flawless movement in the air, sea and land. By using their effectiveness and ability to work in harmony, we have implemented these various characteristics in the development of mounts and connecting mechanisms to the TV. We have succeeded to harness the most efficient movement of animals, to our new product design, which we transformed the viewing possibility to a more diversified application as compared to what is presently available in the market.

### ***Innovative & exclusive Butterfly Connection***

Registered Design (pending) 955760



# 12"-42" LCD Wall Mounts

## 30-107cm

33

### 3 Movement

Rotate, Swivel & Tilt

Color

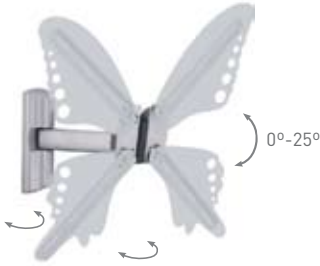

- Minimum distance from wall: 3.25"/8.5 cm
- Maximum distance from wall: 10.25"/26 cm

34

### 4 Movement

Fold, Rotate, Swivel & Tilt

Color

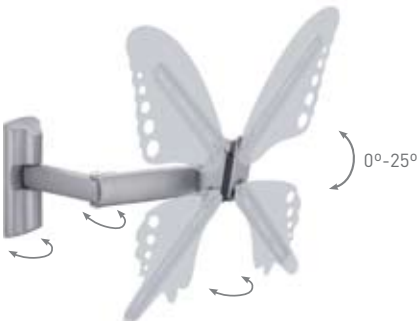

- Minimum distance from wall: 4.25"/11 cm
- Maximum distance from wall: 17.25"/44 cm

#### CABLE MANAGEMENT



Hides cables inside the mount for a clean, wire-free look.

#### FRICITION ADJUSTMENT



One handed tighten or release tilt resistance mechanism.

# 12"-42" LCD Wall Mounts

30-107cm

35

## Ceiling Mount

Telescopic, Swivel & Tilt

Color



- Minimum distance from ceiling: 19.25"/49 cm
- Maximum distance from ceiling: 30.25"/77 cm

38

## LCD Mount Adaptor Extension

Color



**NEW**

- For back screen mounting holes up to: 600x400 mm





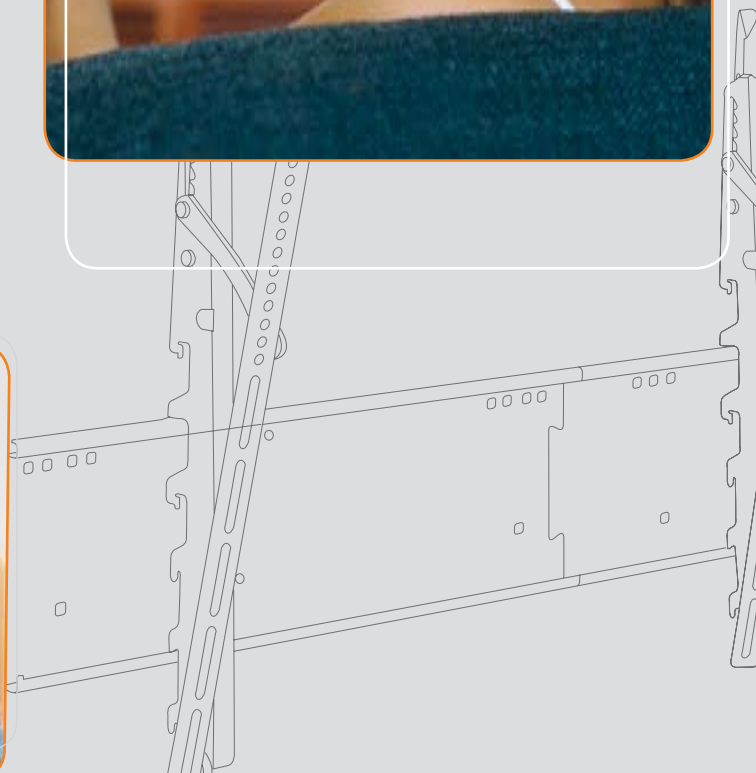

# 40"-60" LCD/Plasma Wall Mounts

102-152 cm

From 37"/94 cm

Streamlined designed mounts with tools free tilting.

**Weight up to:** for models 40-41:143lbs/65kg,

for models 43-44: 100lbs/60kg,

for model 45: 132lbs/60kg.

**40P**

## PRO Fixed

Color

Weight up to: 176lbs/80kg



**NEW**

•Distance from wall: 1.8"/4.6 cm

### HEIGHT ADJUSTMENT

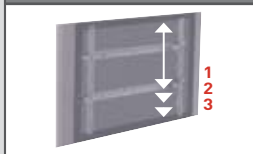

Choice of 3 height positions for enhanced viewing quality

### LEFT & RIGHT ADJUSTMENT

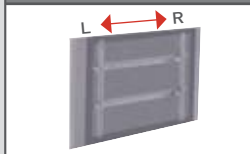

Easy screen positioning during installation, for enhanced viewing quality

### SELF ASSEMBLY

as easy as **1-2-3**

- 1- Install the bracket on the wall.
- 2- Attach the mounting fixture to the screen.
- 3- Snap the screen onto the wall bracket.

### TOUCH & TILT



Tools free tilt adjustment, enabled by automotive friction brake-pads.

40

### Fixed

Color

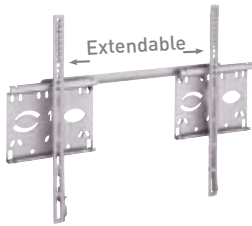

- Distance from wall: 1.6"/4 cm

41

### Tilt

Color

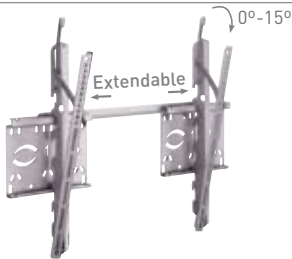

- Distance from wall: 2.4"/6 cm

43

### 3 Movement

Color

Rotate, Swivel & Tilt

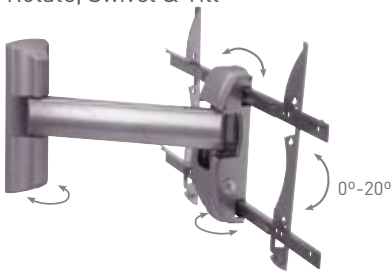

- Minimum distance from wall: 3.75"/9.5 cm
- Maximum distance from wall: 21.5"/54.5 cm

#### FALL & THEFT PROOF



Secure locking system, preventing theft and accidents.

#### SCREEN LEVELING



A built-in mechanism to adjust the screen.

# 40"-60" LCD/Plasma Wall Mounts

102-152 cm (From 37"/94 cm)

44

## 4 Movement

Fold, Rotate, Swivel & Tilt

Color

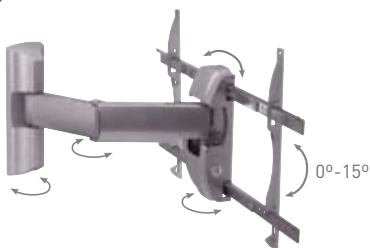

- Minimum distance from wall: 5.25"/13 cm
- Maximum distance from wall: 22.75"/57.5 cm

45

## Telescopic 360°

Swivel & Tilt

Color

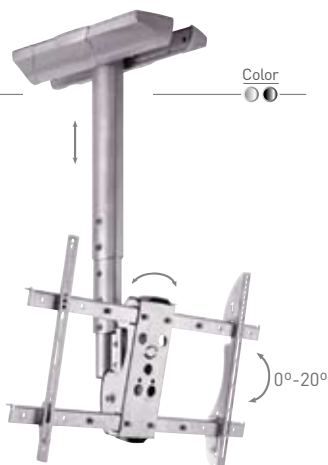

- Minimum distance from wall: 28.75"/73 cm
- Maximum distance from wall: 44"/112 cm

45M

## Telescopic, 360°, Swivel & Tilt PRO Ceiling Mount.

With functional Ceiling Mounting Plate.



### CABLE MANAGEMENT



Hides cables inside the mount for a clean, wire-free look.

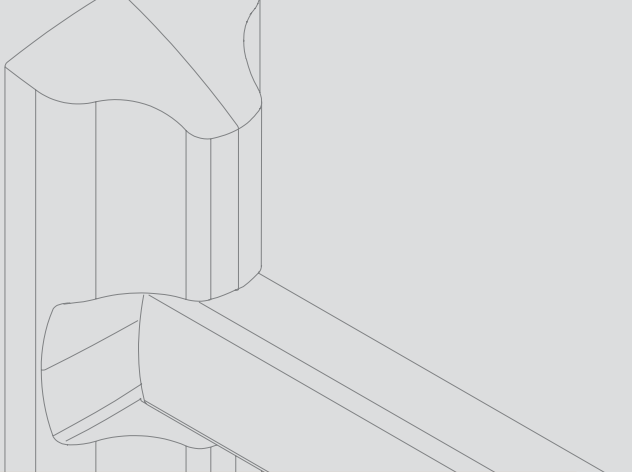

# Fits up to 70" LCD/Plasma Wall Mounts

Fits up to 178 cm

Exclusively designed mounts for large flat screens.

Weight up to: 187lbs/85kg

For back screen mounting holes up to 1200 x 650 mm

60

Fixed

Color

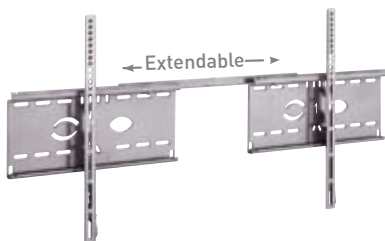

•Distance from wall: 1.6"/4 cm

61

Tilt

Color

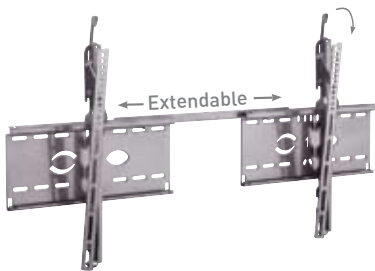

•Distance from wall: 2.4"/6 cm

## SELF ASSEMBLY

as easy as **1-2-3**

- 1- Install the bracket on the wall.
- 2- Attach the mounting fixture to the screen.
- 3- Snap the screen onto the wall bracket.

## TOUCH & TILT

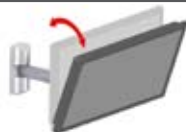

Tools free tilt adjustment, enabled by automotive friction brake-pads.

**63**

### 3 Movement

Rotate, Swivel &amp; Tilt

Color

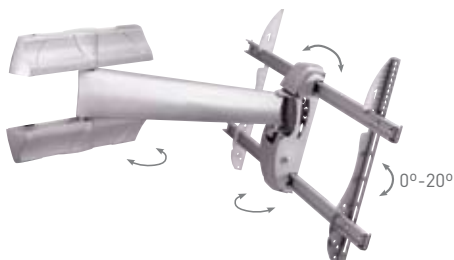

- Minimum distance from wall: 4"/10 cm
- Maximum distance from wall: 25.75"/65 cm

**64**

### 4 Movement

Swivel &amp; Tilt

Color



- Minimum distance from wall: 5.25"/13 cm
- Maximum distance from wall: 33"/84 cm

#### FALL & THEFT PROOF



Secure locking system,  
preventing theft and accidents.

#### SCREEN LEVELING



A built-in mechanism to adjust  
the screen.

# Fits up to 70" LCD/Plasma Wall Mounts

## Fits up to 178 cm

65

### Ceiling Mount

Telescopic, Swivel & Tilt

Color



- Minimum distance from wall: 28.75"/73 cm
- Maximum distance from wall: 48.25"/122.5 cm

65M

### Telescopic, 360° Swivel & Tilt PRO Ceiling Mount.

With functional Ceiling Mounting Plate.



### CABLE MANAGEMENT



Hides cables inside the mount for a clean, wire-free look.





## Wall Mounted Audio Video Shelves

Complete and aesthetic solution for setting up a comprehensive array of audio/visual equipment in the living room.

- Compatible with all other LCD/Plasma mounts.
- Multiple shelves connect as modular units.
- For: DVD, Cable/Satellite box, VCR & other components.
- Hides cables inside the mounting systems and along the wall.
- Integrated with Barkan models: 32,33,34,43,44

80

### Elegant Audio Video Shelf

Color

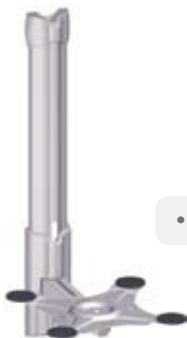

- Weight up to: 55lbs/25kg





**NEW**  
Release 01/09

## Modular shelf & mounting options



Any LCD/Plasma mount

### CABLE MANAGEMENT

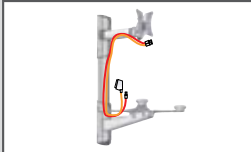

Hides cables inside the system for a clean, wire-free look.

### UP TO 3 COMPONENTS



Up to 3 components (like: DVD, Cable Satellite box, VCR etc.) on one shelf

# Projector Ceiling Mounts

Exclusively designed projector mounts.

Weight up to: 25lbs/11kg

## 90 Standard

Color

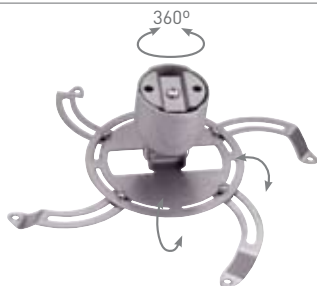

- Distance from ceiling: 4.5"/11.5 cm

## 91 Telescopic

Color

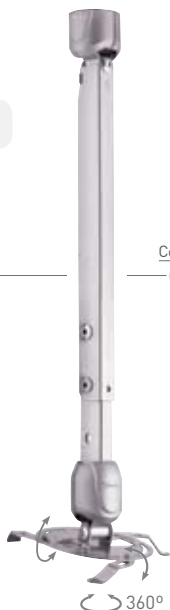

- Minimum distance from ceiling: 22.25"/56.5 cm
- Maximum distance from ceiling: 32.25"/81.5 cm

### TOUCH & TILT



Tools free tilt adjustment.

### FALL & THEFT PROOF



Secure safety catch system, prevents projector from unintentional dismantling.

# Speaker Wall Mounts

Functional design with various connecting options that improve the listening experience.

**Weight up to:** for models 150, 151: 11lbs/5kg,  
for model 152: 25lbs/11kg

## 2 Satellite Speaker Mount

**150** Speaker Wall Mount  
3 ways to connect

Color 

**151** Speaker Wall & Ceiling Mount  
5 ways to connect

Color 



**152** Bookshelf Speaker Wall Mount

Color 

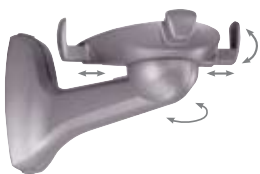

### NON SLIP

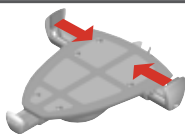

Safety clamp, prevents Speaker from falling.

### CABLE MANAGEMENT

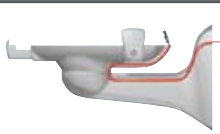

Hides Speaker Cables inside the Mount.

# TV & Audio Video Wall Mounts

## Tools-free tilting and non-slip safety buckle.

These mounts are specially designed for TV's and comply with the most stringent international standards for quality and safety. Several features in the mount greatly enhance the viewing experience, including: tools-free tilt adjustment, cable management, and an international patented mechanism for the prevention of slipping, by a specially designed safety buckle.

### TV Wall Mount Premium Series

Hides cables inside the mount, Barkan's top line, suitable for home entertainment systems.

111

Fits TV's up to: **21"/55 cm**

3 Movement Rotate, Swivel & Tilt

Color



• Weight up to: 70lbs/42kg

113

Fits TV's up to: **29"/72 cm**

3 Movement Rotate, Swivel & Tilt

Color



• Weight up to: 119lbs/54kg

#### NON SLIP

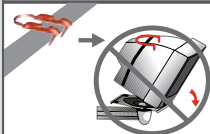

Patent No. B2 6,708,942

Safety buckle prevents TV from sudden release or falling.

#### EASY TILT



Patent No. 6000560

Allows tilting adjustment while TV is on the mount.

## TV Wall Mount Deluxe Series

An aesthetic alternative at a great price.

123

Fits TV's up to: **17"/43 cm**

3 Movement Rotate, Swivel & Tilt

Color



• Weight up to: 50lbs/30kg

124

Fits TVs up to: **21"/55 cm**

3 Movement Rotate, Swivel & Tilt

Color



• Weight up to: 70lbs/42kg



### CABLE MANAGEMENT



Hides cables inside the mount for a clean, wire-free look.

### 3 WAY ADJUSTMENT



Allows visibility from a wide range of directions.

## TV Wall Mount Deluxe Series

125

Fits TVs up to: 27"/68 cm

Color

3 Movement Rotate, Swivel & Tilt



- Weight up to: 95lbs/50kg

## TV Wall Mount Deluxe Special

Non-standard mounts with flexible turn & tilt.

127

Fits TV's up to: 27"/68cm

Color

4 Movement Fold, Rotate, Swivel & Tilt



- Weight up to: 95lbs/43kg



# Audio Video Mounts

For: DVD, Satellite Receiver, Cable Box, VCR or similar components.

## 82 Audio Video Mount

Color



- Weight up to: 25lbs/11kg

## 86 TV & Audio Video Wall Mount

Color



**Combo** up to: 21"/55 cm

3 Movement Rotate, Swivel & Tilt



- Weight up to: 70lbs/42kg

### FOR 1 OR 2 COMPONENTS



2 height adjustment to fit a number of components.

### COMPATIBLE



Compatible with the complete range of Barkan TV mounts.

# Barkan Vision & Strategy

Since its establishment in 1988, Barkan Mounting Systems has specialised in enriching the customers Home Entertainment experience through the development, manufacturing and marketing of superior mounting solutions for LCD, Plasma and other Consumer Electronic products which give the best value for money. The knowledge and experience collected over the years has been the backbone of our success.



## Our Vision:

Barkan's vision is to be a world leader and a global brand in the field of mounting solutions for consumer electronics. In the coming years, we plan to continue developing new products and marketing tools at an increasing rate. Our products will be easy to install, simple to use and aesthetic. We constantly invest in customer satisfaction, and apply this knowledge to all marketing materials, products and services. Barkan is a company that executes all planned strategies with consistency and high moral values. We continue to improve and maintain competitively priced products while adapting ourselves to a dynamically changing market.

### To achieve this vision we have developed the Triangle model:

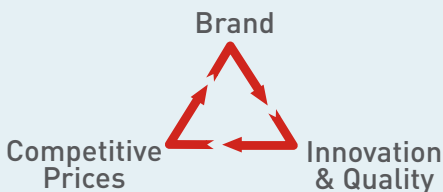

- **A world recognized brand** - An international brand designed to enhance the joy and pleasure of the customers viewing experience. Barkan packaging and marketing materials focus on a consistent, recognizable look that emphasizes the superior lifestyle qualities the products provide.
- **Innovation & Quality** - Barkan's state of the art products include unique patented features that improve the viewing experience. All products carry a Lifetime Warranty and meet the strict demands of American and European regulations, in compliance with UL & TUV Standards.
- **Competitive Prices** - Barkan continues to deliver the most cost effective solutions, along with real value for money, as expected from a market leader.

For further information, visit us at:  
[www.barkanmounts.com](http://www.barkanmounts.com)

# Barkan LCD/Plasma Mount Selection Guide

In 3 steps **A** → **B** → **C**

**A**

What is your screen size?



12" - 26"  
30-66cm

12" - 42"  
30-107cm

40" - 60"  
102-157cm  
From 37" (94cm)

Up to 70"  
Up to 178cm

**B**

What is your sitting position in relation to the screen?

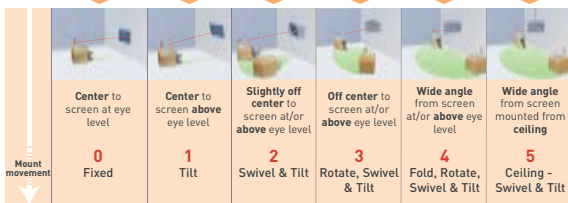

**C**

Choose your model - For the ultimate viewing experience, position the screen towards you.

Models	20	21	22	23	24	—	
Max Weight	66lbs/30kg			44lbs/20kg			
	<ul style="list-style-type: none"> <li>•For back screen mounting holes: 75x75, 100x100mm, for up to 200x200 mm use mount with <b>38</b> LCD Mount Adaptor Extension.</li> <li>•Screws included: M4.</li> </ul>						
Models	30P	30	31	32	33	34	35
Max Weight	132lbs/60kg	66lbs/30kg					
	<ul style="list-style-type: none"> <li>•For models 30-35: back screen mounting holes 75x75, 100x100, 100x200, 200x200, up to 400 x 400 mm, for up to 600 x 400 mm use mount with <b>38</b> LCD Mount Adaptor Extension.</li> <li>•For model 30P: back screen mounting holes up to 400 x 400 mm.</li> <li>•Screws included: M4, M5, M6m.</li> </ul>						
Models	40P	40	41	Screen too wide to swivel, so there is no option to turn.	43	44	45
Max Weight	176lbs/80kg	143lbs/65kg			100lbs/60kg		132lbs/60kg
	<ul style="list-style-type: none"> <li>•For models 40-45: back screen mounting holes up to 800x455 mm.</li> <li>•For model 40P: back screen mounting holes up to 800x450 mm.</li> <li>•Screws included: M5, M6, M8.</li> </ul>						
Models	60	61	Screen too wide to swivel, so there is no option to turn.	63	64	65	
Max Weight	187lbs/85kg			187lbs/85kg			
	<ul style="list-style-type: none"> <li>•For back screen mounting holes up to 1200 x 670 mm.</li> <li>•Screws included: M5, M6, M8.</li> </ul>						

Also compatible to larger screen sizes, where their specifications comply to the mount.

\* Special order

Few products are still under development.  
See more information in the relevant chapter.

Europe & Headquarter: Tel: + 972 3 936 7404  
Fax: + 972 3 936 7405  
sales.eu@barkanmounts.com

Germany: Tel: + 49 221 98944970  
Fax: + 49 221 2711006  
barkan.de@barkanmounts.com

Italy: Tel: +39 02 5460204  
Fax: +39 02 59902067  
barkan.italy@barkanmounts.com

USA: Tel: +1 (646)-723 2342  
Fax: +1 (866)-428 5784  
sales.usa@barkanmounts.com

www.barkanmounts.com

**Barkan** A better point of view™